

VICINITY MAP
NOT TO SCALE

PROPOSED PLANT SCHEDULE

TREES:					
QTY	KEY	BOTANICAL NAME	COMMON NAME	SIZE	ROOT
2	FA	FRAXINUS AMERICANA	WHITE ASH	3"-4" CAL.	B&B
3	BP	BETULA POPULIFOLIA	GRAY BIRCH	6"-8" HGT.	B&B
SHRUBS:					
QTY	KEY	BOTANICAL NAME	COMMON NAME	SIZE	ROOT
18	CO	CORNUS SPECIES	DOGWOOD	2 1/2'-3'	B&B

TREE AND SHRUB SUBSTITUTES TO BE APPROVED BY THE CONSERVATION AGENT.

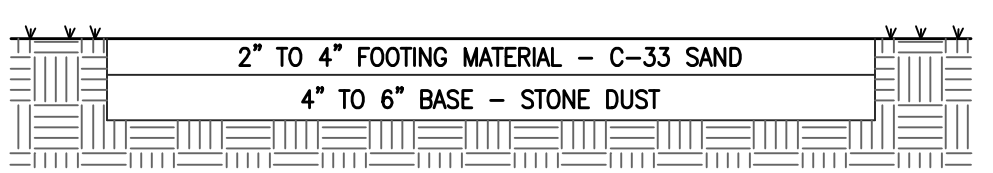

HORSE Paddock/RIDING AREA CROSS SECTION
NOT TO SCALE

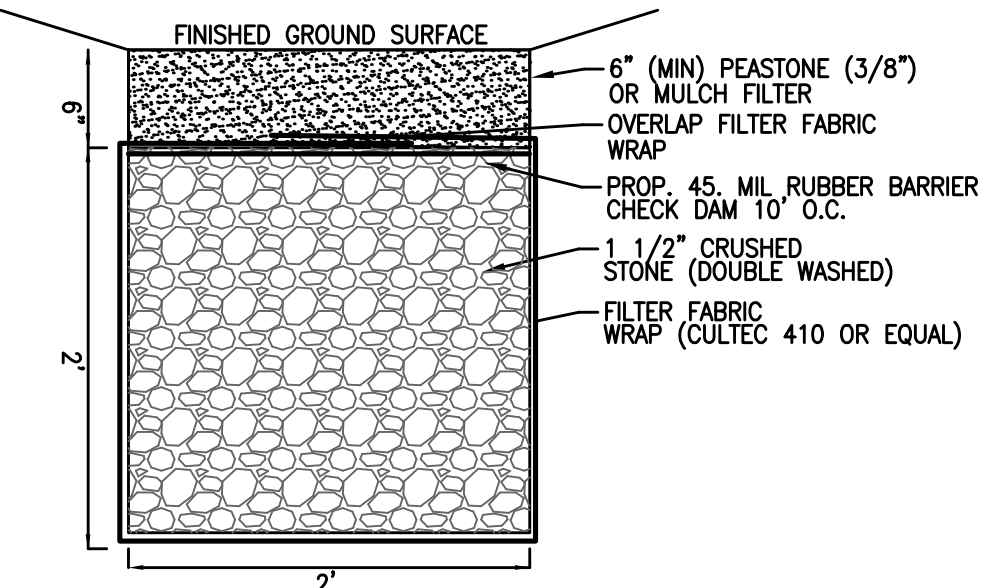

CRUSHED STONE TRENCH DRAIN
NOT TO SCALE

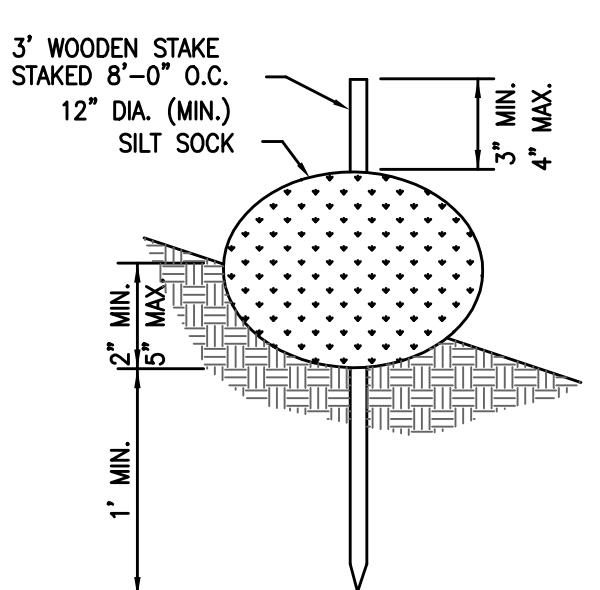

STAKED SILT SOCK DETAIL
NOT TO SCALE

79 ATLANTIC AVENUE
F4-31-21
N/F
79 ATLANTIC LLC
L.C. CERT. 170606

83 WHITEHEAD ROAD
F4-31-25
N/F
THOMAS D. SULLIVAN
L.C. CERT. 181122

F4-31-25A
LOT 16
1.471 ACRES

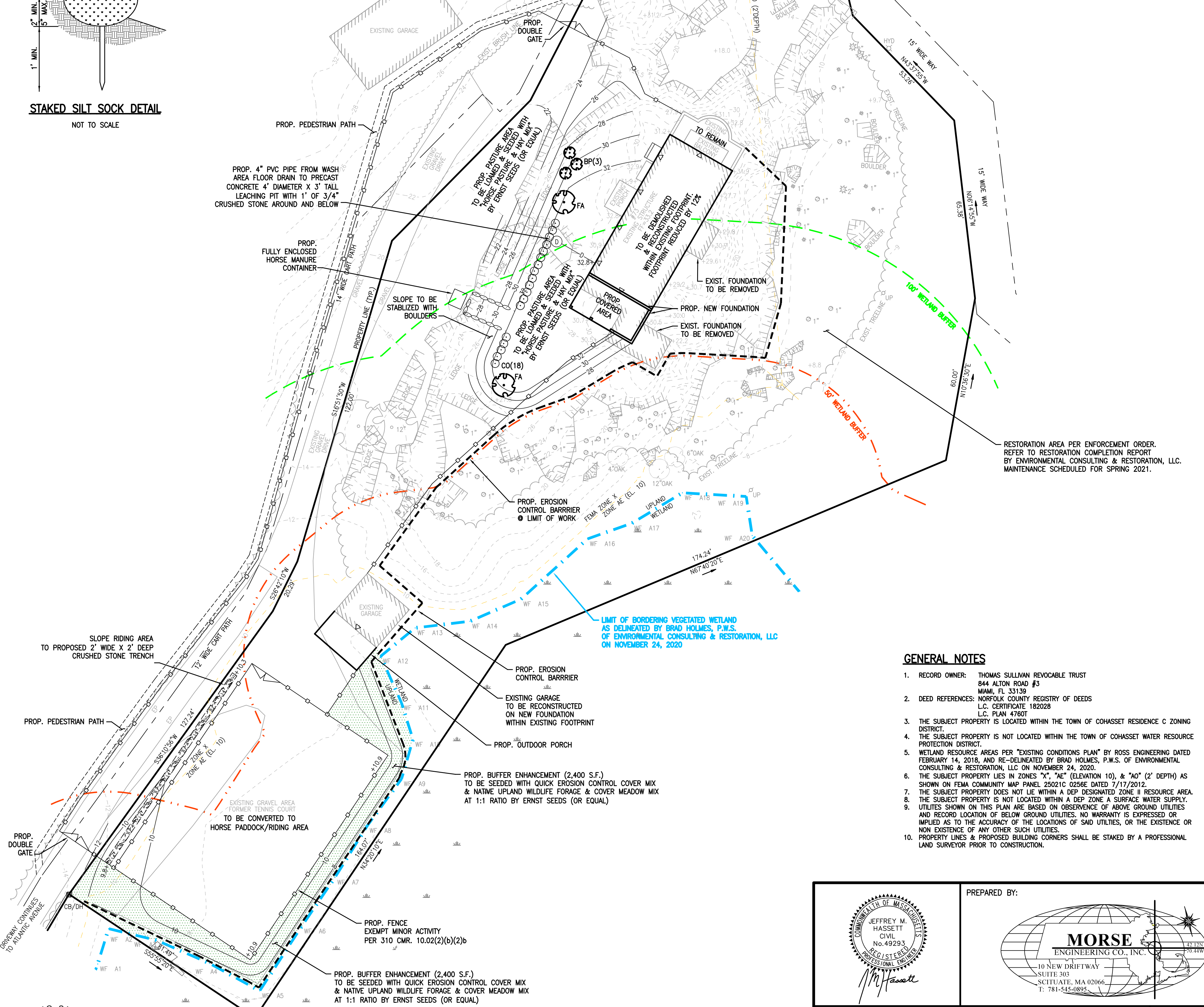

RESTORATION AREA PER ENFORCEMENT ORDER. REFER TO RESTORATION COMPLETION REPORT BY ENVIRONMENTAL CONSULTING & RESTORATION, LLC. MAINTENANCE SCHEDULED FOR SPRING 2021.

GENERAL NOTES

- RECORD OWNER: THOMAS SULLIVAN REVOCABLE TRUST, 844 ALTON ROAD #3, MIAMI, FL 33139
- DEED REFERENCES: NORFOLK COUNTY REGISTRY OF DEEDS, L.C. CERTIFICATE 182028, L.C. PLAN 47607
- THE SUBJECT PROPERTY IS LOCATED WITHIN THE TOWN OF COHASSET RESIDENCE C ZONING DISTRICT.
- THE SUBJECT PROPERTY IS NOT LOCATED WITHIN THE TOWN OF COHASSET WATER RESOURCE PROTECTION DISTRICT.
- WETLAND RESOURCE AREAS PER "EXISTING CONDITIONS PLAN" BY ROSS ENGINEERING DATED FEBRUARY 14, 2018, AND RE-DELINEATED BY BRAD HOLMES, P.W.S. OF ENVIRONMENTAL CONSULTING & RESTORATION, LLC ON NOVEMBER 24, 2020.
- THE SUBJECT PROPERTY LIES IN ZONES "X", "AE" (ELEVATION 10'), & "AO" (2' DEPTH) AS SHOWN ON FEMA COMMUNITY MAP PANEL 25021C 0256E DATED 7/17/2012.
- THE SUBJECT PROPERTY DOES NOT LIE WITHIN A DEP DESIGNATED ZONE II RESOURCE AREA.
- THE SUBJECT PROPERTY IS NOT LOCATED WITHIN A DEP ZONE A SURFACE WATER SUPPLY.
- UTILITIES SHOWN ON THIS PLAN ARE BASED ON OBSERVATION OF ABOVE GROUND UTILITIES AND RECORD LOCATION OF BELOW GROUND UTILITIES. NO WARRANTY IS EXPRESSED OR IMPLIED AS TO THE ACCURACY OF THE LOCATIONS OF SAID UTILITIES, OR THE EXISTENCE OR NON-EXISTENCE OF ANY OTHER SUCH UTILITIES.
- PROPERTY LINES & PROPOSED BUILDING CORNERS SHALL BE STAKED BY A PROFESSIONAL LAND SURVEYOR PRIOR TO CONSTRUCTION.

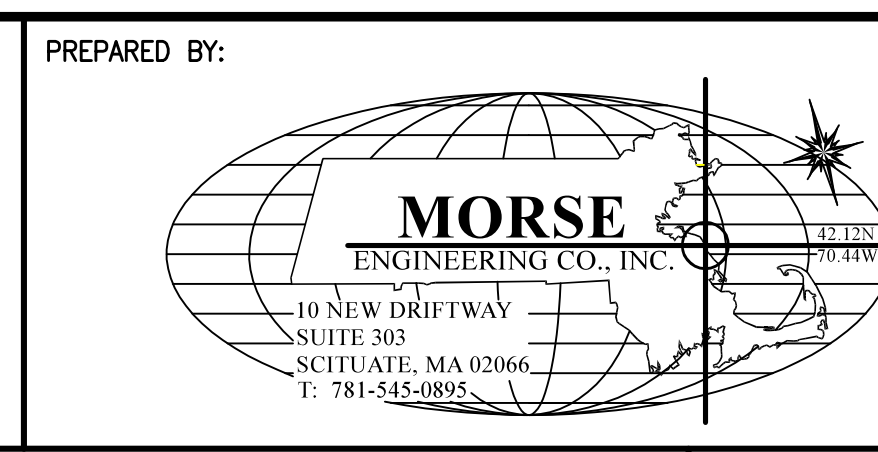
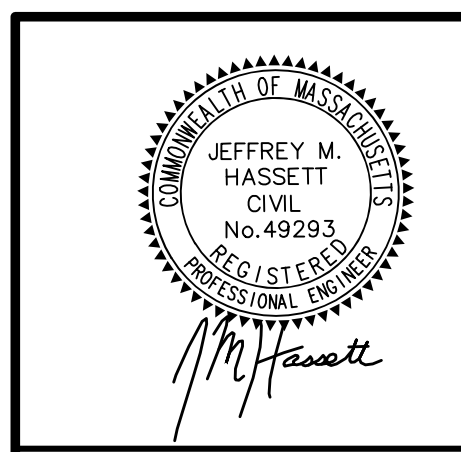

68 WHITEHEAD ROAD
F4-31-22
N/F
ROSS & SARAH FAIRBANKS

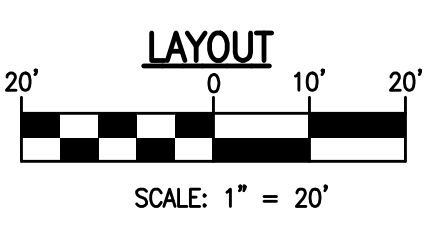

ZONING:

CRITERIA	REQUIRED
RESIDENCE C	60,000 S.F.
LOT AREA:	50'
FRONTAGE:	150'
WIDTH:	30'
FRONT SETBACK:	20'
SIDE SETBACK:	30'
REAR SETBACK:	35'
BUILDING HEIGHT:	

PROJECT:	73 ATLANTIC AVENUE (ASSESSORS PARCEL: F4-31-25A) COHASSET, MASSACHUSETTS	DESIGN:	JMH
APPLICANT:	THOMAS SULLIVAN	JOB NO:	21-102
PLAN TITLE:	PROPOSED SITE PLAN	DATE:	2/2/2021
		REV:	3/29/2021
		SHEET:	1