

Alternative Energy Committee

Quarterly Report to the Board of Selectmen

August 25, 2020



**Town of
Cohasset
Massachusetts**

**Alternative
Energy
Committee**

Contents

Objective: Provide the Q22020 quarterly report of the Alternative Energy Committee to the Board of Selectmen

Agenda:

- Alternative Energy Committee
- Community Choice Electric Aggregation
- Solar Update
- Microgrid Resiliency Framework
- Grant Opportunities
- Questions



Goals/Objectives

- Investigate and identify alternative energy resources and opportunities for municipal energy efficiency and resilience;
- Support the Town Manager and his staff in exploring grants and procurement options that **maximize safety, energy efficiency, and reduced emissions**;
- Investigate **community-wide, residential and business**, energy efficient and clean energy options;
- Contribute to **public awareness** and **education on Town initiatives** and long-term benefits of achieving Cohasset's strategic energy efficiency objectives;
- Together with the Town Manager, report to the BOS quarterly on the Town's progress and the cost-saving benefits of meeting the objectives of the Green Community status and other energy-based policies that benefit the Town and its citizens; and
- Support other committees, as requested by the Board of Selectmen.

The new charge reaches out to benefit citizens of the Town



Alternative Energy Committee

Members are rolling off and new talent is in queue!

The Alternative Energy Committee shall consist of seven members of the public plus a liaison from the Town with “demonstrated interest and relevant skills:”

- **Tanya Bodell (Chair)** – more than 25 years serving as an advisor to companies in the energy industries; former chair of the AEC 2011-2013
- **Patricia Gooding (Vice Chair)** – returning to the committee for her fourth year, played a crucial role in bringing Cohasset energy consumption data into the Green Communities database
- **Steve Wenner** – longest standing member of the AEC since 2012 as a champion of solar, Green Communities and now community aggregation
- **Michael Schmitt** – term ending worked at Pilgrim Nuclear Plant, Eversource, and now Hull Municipal Light Plant – would like to renew
- **OPEN SEAT** - Mary Jo Larson –voluntarily rolling off
- **OPEN SEAT** - Bill Fusco – term ending and rolling off
- **OPEN SEAT** – Formerly Steve Girardi (now Water Commissioner)

Seats to be Filled

We have a great slate of applicants – all of whom have contributed



**Town of
Cohasset
Massachusetts**

**Alternative
Energy
Committee**

Community Choice Aggregation

Timeline: Waiting for DPU approval

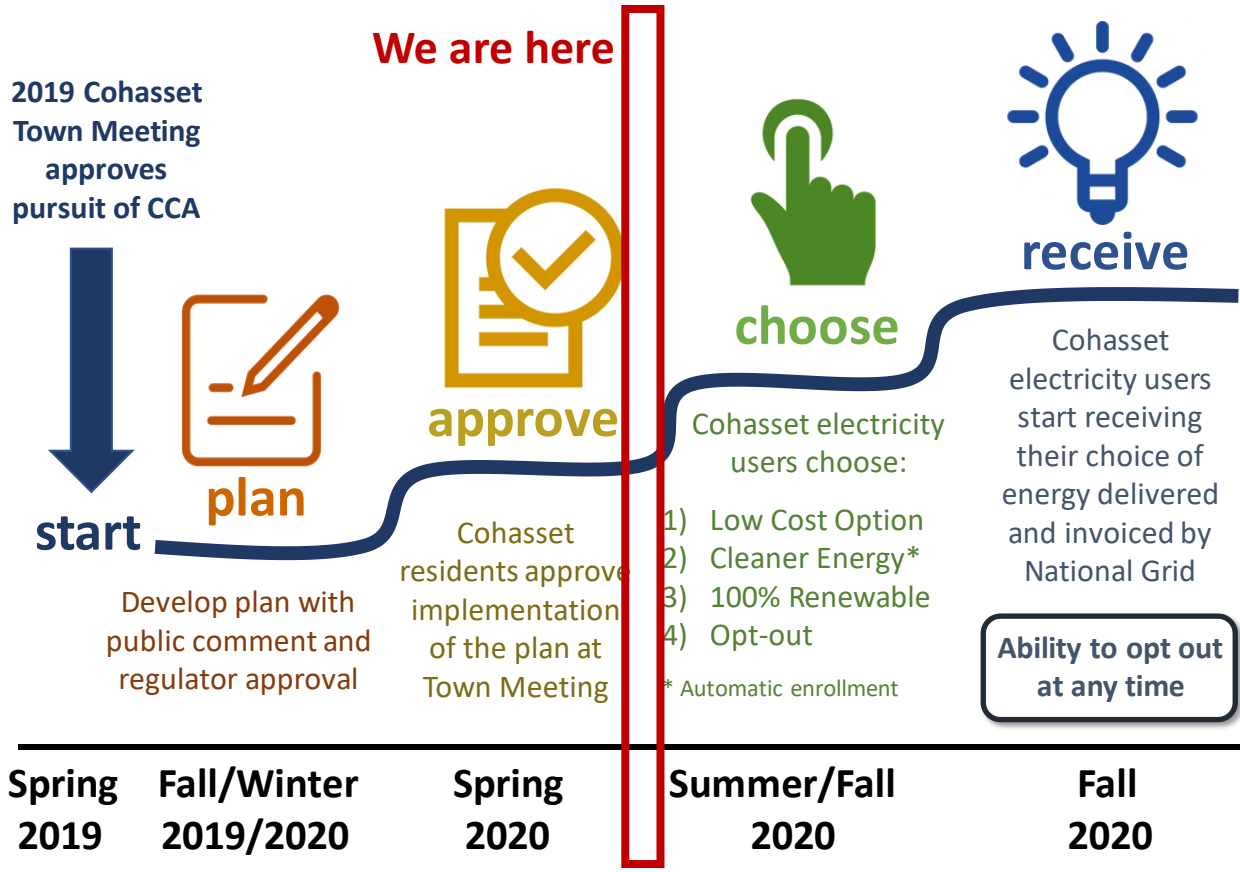

Plan submitted to the DPU for review; implementation requires Town approval



Next Steps

KEY PROGRESS

- **Consultant Contracted** - Town signed contract with Good Energy
- **Plan Completed** – Plan finalized for review
- **Public Review** – DOER requires that citizens have 2 weeks to review the plan and provide comments/input at public meetings (2 weeks)
- **Plan Submitted for Review** – Good Energy submits the plan to the DOER and DPU for review
- **DOER Review** – DOER reviews the submitted plan (6 – 8 weeks)
- **DPU Review** – DPU reviews the submitted plan (6 – 8 months)

NEXT STEPS

- Obtain DPU approval and then take the offer to town

Select Board will need to review offers to make a go/no-go decision



Solar Update

Nearly 3 years of savings!

PRODUCTION

1,785K kWh

SATISFIES AROUND 22% OF
COHASSET MUNICIPAL USAGE

SAVINGS

\$173K

AVERAGES \$4,810 PER MONTH,
OR \$160 PER DAY

CO₂ REDUCTION

2,713K LBS

TYPICAL NON-SOLAR SOURCES IN
MA WOULD HAVE PUT **2.7M** LBS
OF CO₂ INTO THE ATMOSPHERE



**Town of
Cohasset
Massachusetts**

**Happy 3rd Birthday to our Solar Array!
August 30, 2017**

**Alternative
Energy
Committee**

Solar Update

2019 was a blockbuster summer

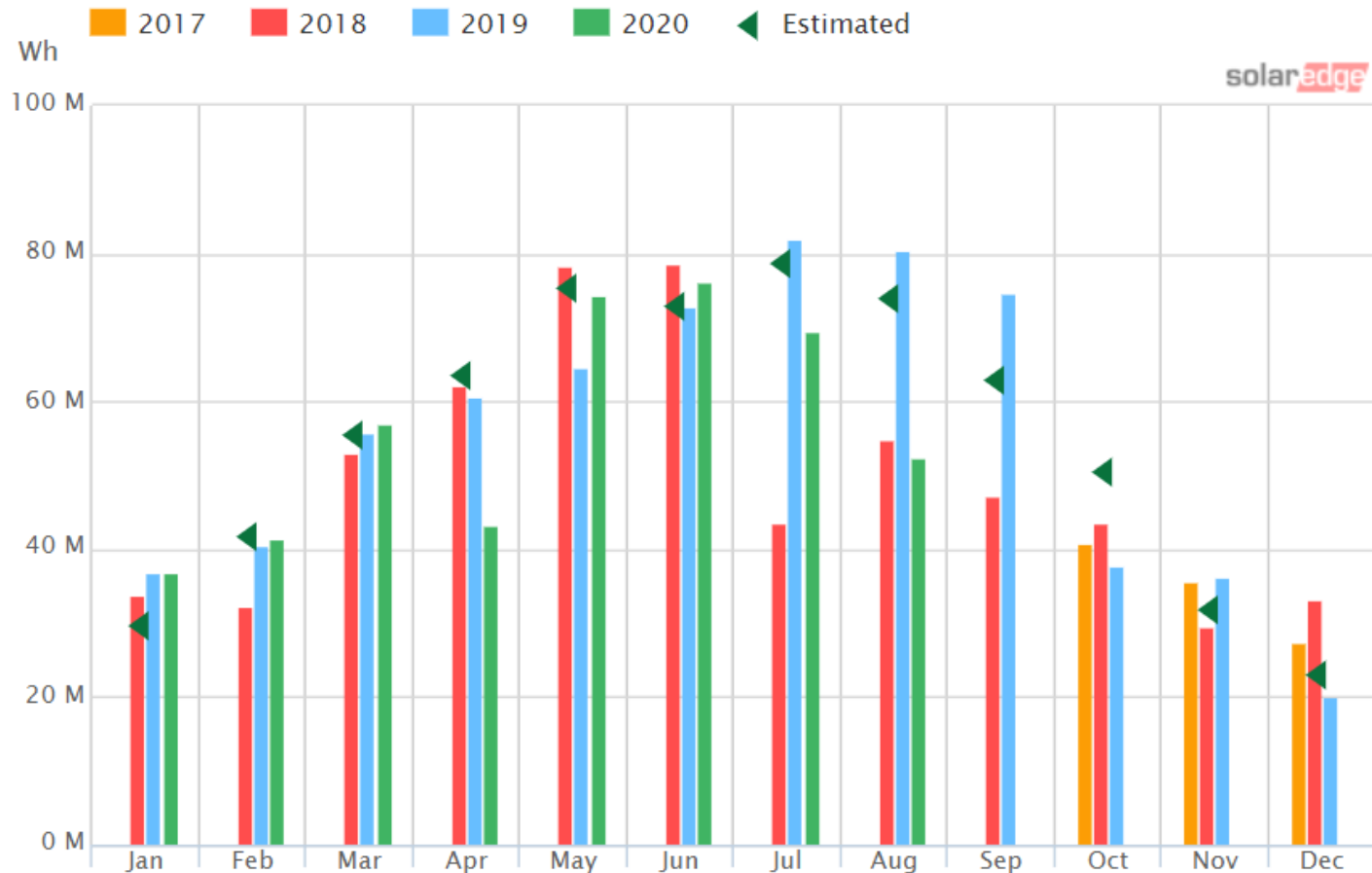

**Town of
Cohasset
Massachusetts**

**Thank you to Palmer Capital for their
operations and professionalism!**

**Alternative
Energy
Committee**

RFP being finalized for issuance

Long-term
Power
Purchase
Agreement



Town
Site

- EXAMPLE: Old Landfill
- Six Town sites pre-approved to authorize lease under Ch. 30B
- Additional sites examined by Solect Energy/Power Options (MGL Chap. 164, Sec. 137)

Price Savings = ?
Lease Cost = \$0
PILOT = \$0

Public
Site

- EXAMPLE: MBTA Canopies
- Long-term contract signed by Town
- Developer builds solar

Price Savings = ?
Lease Cost = ?
PILOT = ?

Private
Site

- EXAMPLE: Commercial Building Rooftop
- Long-term contract signed by Town
- Developer leases land

Price Savings = ?
Lease Cost = ?
Property Taxes = ?

Need to compare economics of town sites versus private and public sites



Groundwork being laid as we “skate towards the puck”

KEY PROGRESS

- **Established Microgrid Subcommittee**
 - Steve Girardi
 - Mike Schmitt
 - Tyler Thibault
- **Conceptual Framework**
 - Developed by Microgrid Subcommittee
 - Approved by the AEC 5/13/2020
- **Communications with ecosystem of potential partners**
 - National Grid
 - Vendors (Ameresco, ENGIE, STEM, Palmer Capital)
 - MAPC
- **Grants have been submitted**



Microgrid Resiliency Framework

Cohasset has two different power supply goals

- **Reliability:** The ability of the electric system to supply the aggregate electric power and energy requirements of the electricity customers at all times taking into account scheduled and reasonability expected unscheduled outages.
- **Resiliency:** The ability to reduce the magnitude and/or duration of disruptive events. The effectiveness of a resilient infrastructure or enterprise depends upon its ability to anticipate, absorb, adapt to, and/or rapidly recover from a potentially disruptive event.

Illustration of Reliability

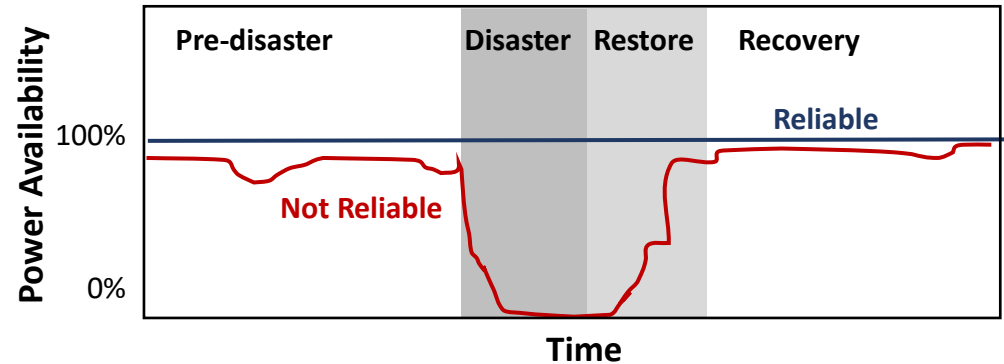
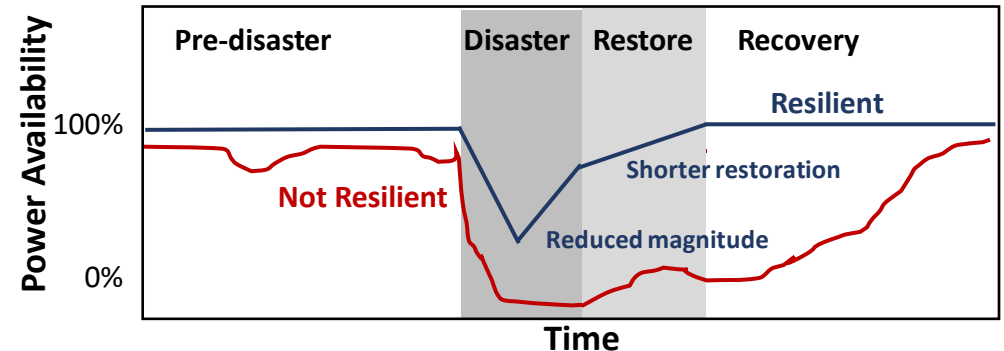

Illustration of Resiliency



Resilient systems suffer less trauma and recover more quickly



**Town of
Cohasset
Massachusetts**

Source: North American Electric Reliability Council,
<https://ics-cert.us.cert.gov/sites/...16/reliability%20and%20resilience%20pdf.pdf>
US DOE, "Staff Report to the Secretary on Electricity Markets and Reliability," August 2017; Mayunga 2007

The AEC studied the issue and developed a framework

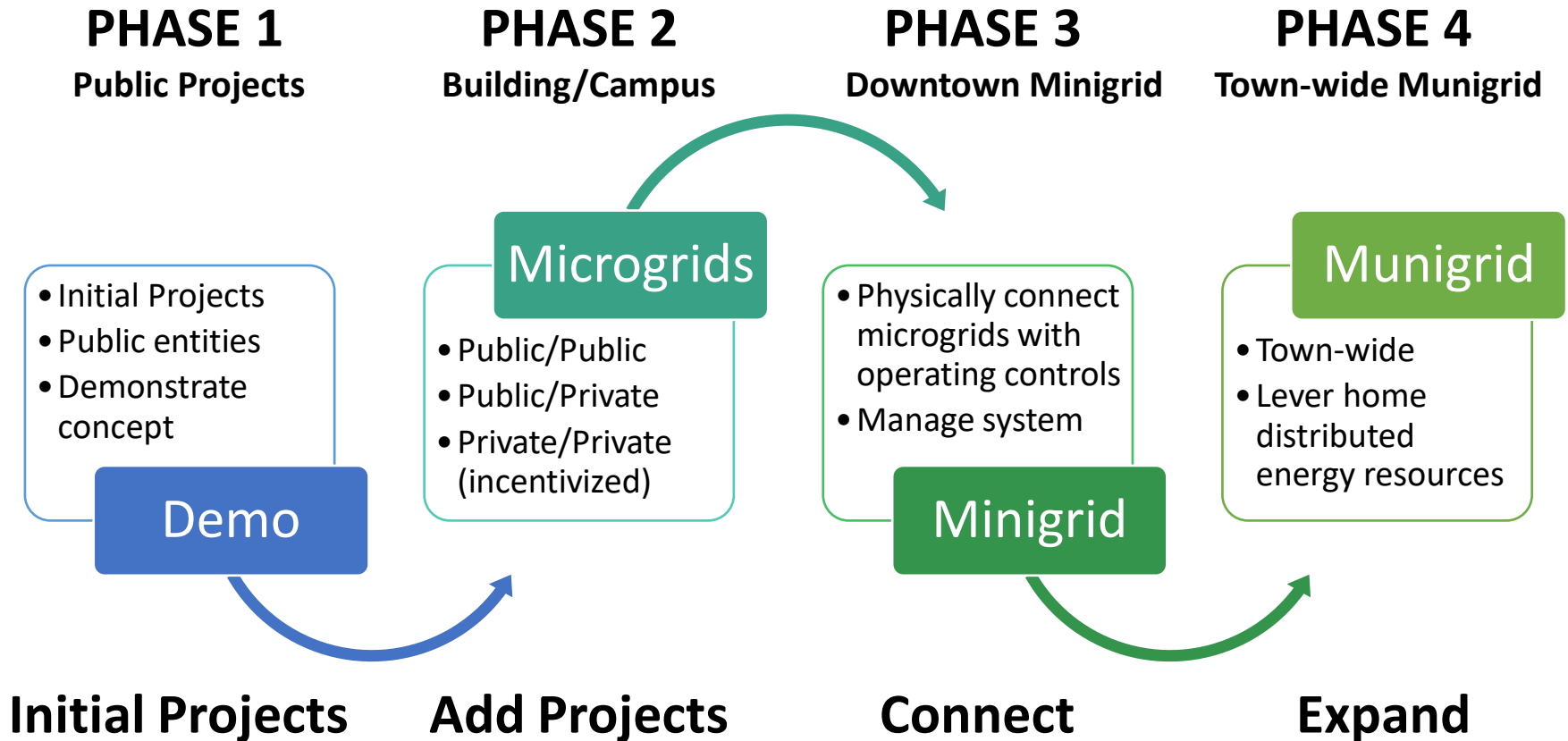

A phased approach also allows for adoption of new technology



Microgrid Resiliency Framework

PHASE 1: Initial Microgrid Projects are public entities

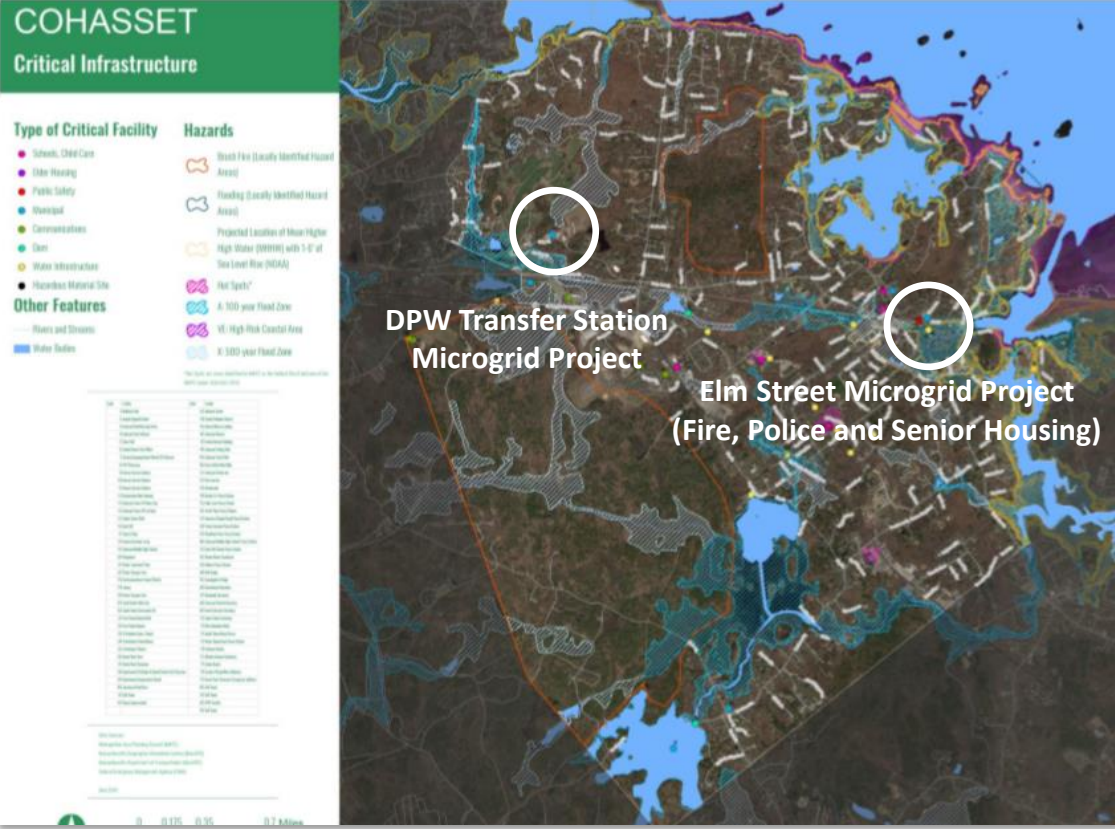
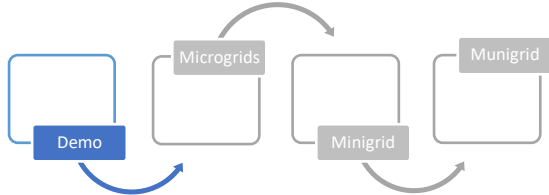

Initial Projects Focus on Resiliency

- Developed in response to MassCEC study grant (submitted April 6, 2020)
- Emphasizes resiliency in the face of storms (DPW snow removal, emergency responders)
- Protects vulnerable populations (ability to get to warm spaces, Harborview)
- Leverages existing generation assets (solar, backup generation)
- Town of Cohasset, Cohasset Housing Authority, MassCEC

Initial projects serve as “bookends” or pillars to a downtown minigrid

Microgrid Resiliency Framework

PHASE 1: Understand microgrid operations

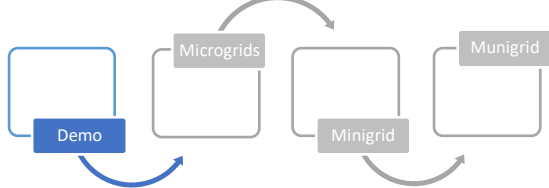

Microgrid Operational Control

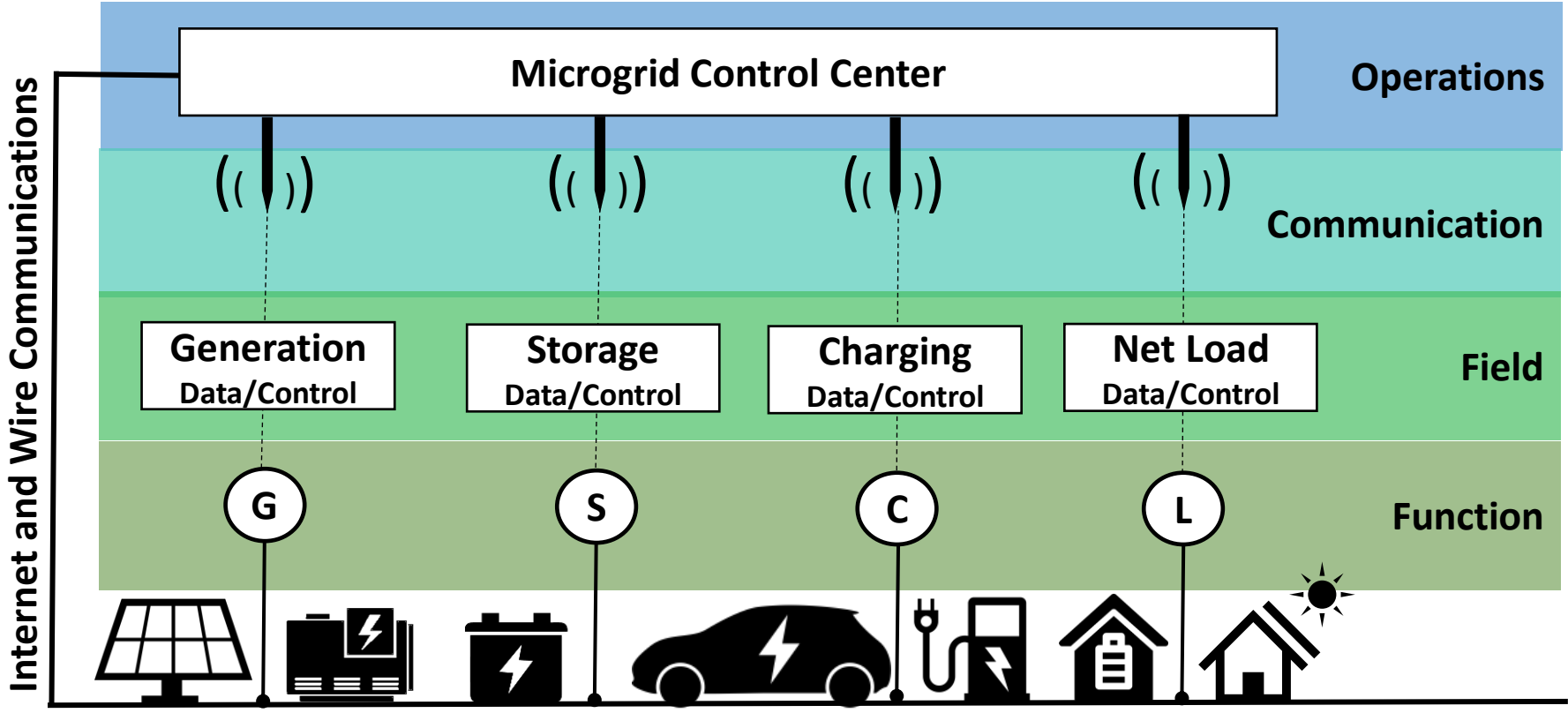

Microgrid functions could be automatic or managed by a third party

Grant Opportunities

Success so far and more to go

- **MassCEC CLEAR Study Grants – submitted April 13, 2020**
 - Applied for two study grants to examine potential microgrid sites
 - **Granted both sites = \$150,000**
 - Kick-off starts within the next two weeks
- **MAPC Application for Technical Assistance through Green Communities**
 - Applied for Technical Assistance grant to review solar sites
 - Granted \$6,000, which was replaced with money for other efforts
 - Rescinded to grant Green Communities technical assistance grants from last year that were not used
- **DOER Technical Assistance Grant**
 - Considered applying for grant to hire consultant for RFP
 - Decided to move forward with prior materials and experience instead
- **Electric Vehicle Charging Stations (VW Settlement and National Grid)**



There is money for microgrid asset funding

- **MVP Action Grant**

- Drafted grant as an add-on to the Town's planning grant for \$125,000 to look at relocating the Police/Fire Station
- Drafted grant request for Emergency Mobile Backup Energy Resource Storage (EMBERS) = \$590,000 battery storage investment
- Given state incentives, the 25% could pay for itself within 1 to 3 years
- Superseded by Town's desire for study to look at relocation

- **FEMA \$500 million in Fiscal Year 2020 Building Resilient Infrastructure and Communities**

- 25% match (which can be in-kind)
- Focused on microgrid issues

<https://www.fema.gov/grants/mitigation/fy2020-nofo#>



Questions

